

Article number: 03504110

Description: Fluro Rod end GE 110LO

Measures

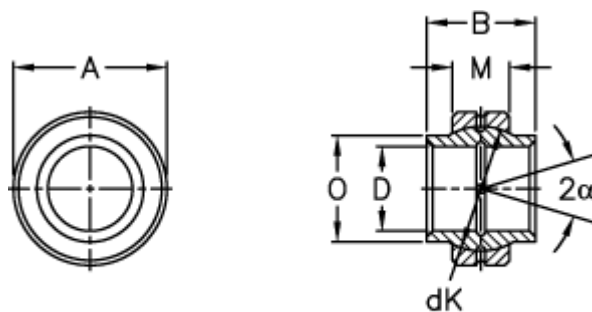

Str. 12 den smørerille

A	= 160 0 -0,025	Tilt angle = 4
B	= 110	Weight = 5500
D	= 110 0 +0,035	
dK	= 140	
Dynamic load C (kN)	= 655	
M	= 55	
O	= 124	
Static load C0 (kN)	= 3250	